

Installation and Operation Instructions Stone Age Indoor Fireplace

Ce manuel est disponible en français à www.stoneagemanufacturing.com.
This manual is available in French at www.stoneagemanufacturing.com.

1.0 Introduction

The following provides instructions for the installation and operation of the Stone Age Fireplace, manufactured by Stone Age Manufacturing, Collinsville, Oklahoma.

Three generations of fireplace knowledge and experience have gone into the design and construction of the New Age series fireplaces. New Age Fireplaces are manufactured to comply with UL127 for the US, and ULCS610 for Canada. They are also manufactured to comply with ICC-ES AC156 meeting structural design requirements for Earthquake Testing at a compliance level of $S_d = 2.5g$. The ICC-ES AC156 complies with 2010 American Society of Civil Engineers (ASCE) 7-10, 2009 International Building Code (IBC), 2010 California Building Code and 2012 ICC-ES AC156. Assembly and Cutaway views of a NA60IND fireplace are shown in Figure 1.

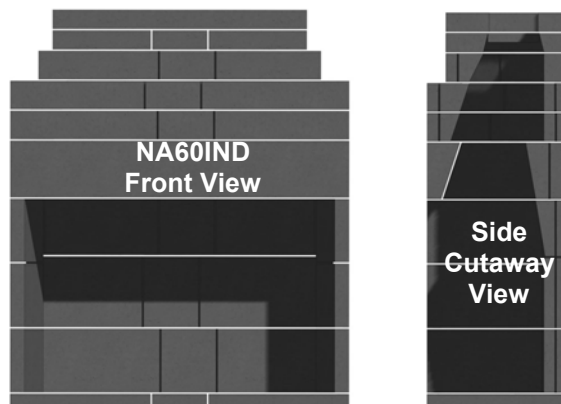

Figure 1. NA60IND Fireplace Assembly & Cutaway View

Because of structural modifications required in an existing home, it is recommended that this fireplace be installed by a professional installer, or by a builder in new construction. Installation by a non-qualified person may negate the warranty.

Keep these instructions for future use.

2.0 Description

The fireplace is delivered as a kit with all components necessary to complete the installation. The kit is configured for a flue chimney, but a special adapter is available for a metal chimney. Component arrangement, some of which is optional, is shown in Figure 2. Components are shown in Table 1. Specifications and installation dimensions are shown in Table 2.

A completed installation should include the following:

- A. Fireplace items shown in Figure 2 and listed in Table 1.
- B. Damper (sold separately) (Shown in Figure 12).
- C. Chimney Cap (sold separately) (Shown in Figure 24).
- D. Fireplace Grate (sold separately) (Shown in Figure 28).
- E. Full firebrick (sold separately)
- F. Stone Age Multi-Purpose Ready-Mix Cement (sold separately).

The Stone Age Fireplace has been manufactured to comply with UL 127 and ULC S610 standards for indoor or outdoor use.

This fireplace is designed to supplement your current heating system. It is not designed to be used as a primary heat source.

Ensure that appropriate building permits required by local codes are obtained before installation in an existing home.

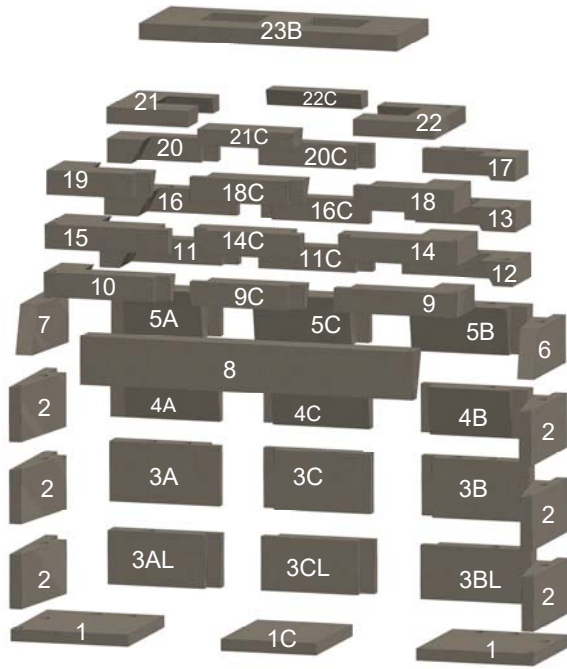

Figure 2. Fireplace Components

Table 1. Fireplace Components

Item	Description
1	Base Plate
1C	Base Plate Extension
2	Lower & Middle Sidewall
3AL	Bottom Back Plate - Left
3BL	Bottom Back Plate - Right
3CL	Bottom Back Plate - Center Extension
3A	Lower Back Plate - Left
3B	Lower Back Plate - Right
3C	Lower Back Plate - Center Extension
4A	Middle Back Plate - Left
4B	Middle Back Plate - Right
4C	Middle Back Plate - Center Extension
5A	Upper Back Plate - Left
5B	Upper Back Plate - Right
5C	Upper Back Plate - Center Extension
6	Upper Slanted Sidewall - Right
7	Upper Slanted Sidewall - Left
8	Front Header
9	Lower Throat - Right Front
9C	Lower Throat - Center Front Extension
10	Lower Throat - Left Front
11	Lower Throat - Left Rear
11C	Lower Throat - Center Rear Extension
12	Lower Throat - Right Rear
13	Middle Throat - Right Rear
14	Middle Throat - Right Front
14C	Middle Throat - Center Front Extension
15	Middle Throat - Left Front
16	Middle Throat - Left Rear
16C	Middle Throat - Center Rear Extension
17	Upper Throat - Right Rear
18	Upper Throat - Right Front
18C	Upper Throat - Center Front Extension
19	Upper Throat - Left Front
20	Upper Throat - Left Rear
20C	Upper Throat - Center Rear Extension
21	Throat Cap - Left
21C	Throat Cap - Center Front Extension
22	Throat Cap - Right
22C	Throat Cap - Center Rear Extension
23B	Double Flue Adapter
23 (not shown)	Masonry Chimney Blocks or Metal Flue Adapters

2.1 Specifications

Table 2: Clearances (See Figure 3)
NA 60 Fireplace

Item	Clearance	Figure 2 Reference
Backwall	0	
Sidewalls	0 to Appliances 18" from Fireplace opening at points in front of fireplace	
Floor: Non combustible extending as follows	20" when hearth is less than 6" from floor 18" when hearth is greater than 6" from floor	A
12" Mantle	60" from hearth	B
Top Trim	48" from hearth	C
Side Trim	6" from fireplace opening	D
Front enclosure	Non combustible from hearth up 36." (E-1) Combustible 36" from hearth (E-2)	E
Hearth	If the fireplace opening is 6 sq feet or larger, the hearth shall extend at least 20 inches in front of the opening and 12 inches beyond each side. If the opening is less than 6 sq feet, the hearth shall extend at least 16 inches in front of the opening and 8 inches beyond each side.	
Clearance around chimney	0" New Age Chimney Block 2" Metal Pipe chimney (UL 103 and ULC S604)	F
Chimney Height	16' from floor	

Note 1: This Fireplace intended for use with solid wood fuel or vented gas logs.

CAUTION: When using this appliance, the fireplace damper must be set in the fully open position.

Note 2: This fireplace has not been tested for use with glass doors.

Note 3: Do not use fireplace insert or other products not specified for use with this model. Use a fireplace grate when burning wood.

Note 4: Clay flue liners installed in flue section meet the specifications of ASTM Section C315-02.

Note 5: Ensure installation complies with local building codes.

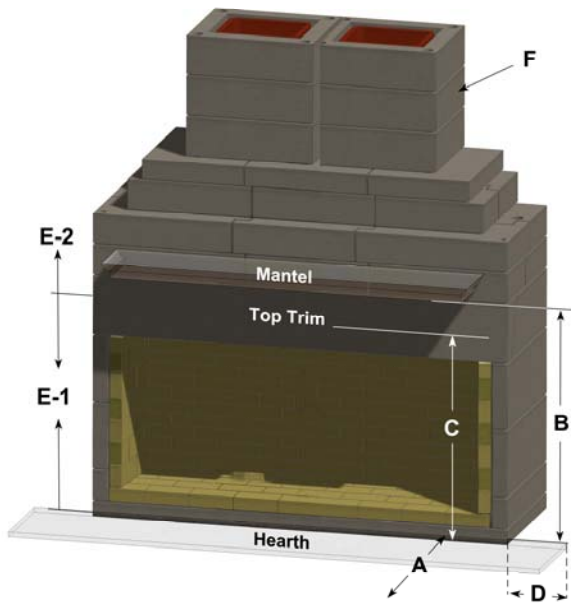

Figure 3. Clearances (Use with Table 2)

2.2 Installation of Additional Equipment

WARNING: THIS FIREPLACE HAS NOT BEEN TESTED FOR USE WITH DOORS. TO REDUCE THE RISK OF FIRE OR INJURY, DO NOT INSTALL GLASS DOORS.

A. Do not install a fireplace insert unless it is tested with this fireplace.

B. Cutting or drilling a hole into the floor or walls for gas supply for a vented decorative gas appliance (log), fresh air venting, or an ash dump, is acceptable.

C. If a decorative gas appliance is installed, it must be installed in accordance with the National Gas Fire Code, ANSI Z223.1.

D. It must incorporate an automatic shutoff device.

E. Installation must comply with the Standard for Decorative Gas Appliances in Vented Appliances, ANSI Z21.60 (1991) or American Gas Association draft requirements for Gas-Fired Log Lighters for Burning Fireplaces, Draft No. 4 dated August 1993.

3.0 Installation of the Fireplace

WARNING: DO NOT USE SUBSTITUTE MATERIALS IN THE ASSEMBLY, INSTALLATION OR OPERATION OF THIS FIREPLACE. TO DO SO WILL VOID THE WARRANTY AND MAY RESULT IN FIRE AND PERSONAL INJURY.

It is most important that the Stone Age fireplace be installed according to the following instructions. It is also important that local building codes be consulted and followed. Improper installation could result in:

- Overheating, leading to fireplace failure
- Leakage of rainwater through and around the chimney
- Cracks and settling because of poor foundations
- Emission of smoke, sparks and gases into the living area
- Combustion of materials adjacent to the fireplace.

WARNING: THIS FIREPLACE HAS NOT BEEN TESTED WITH AN UNVENTED GAS LOG SET. TO REDUCE THE RISK OF FIRE OR INJURY, DO NOT INSTALL AN UNVENTED GAS LOG SET INTO THIS FIREPLACE.

Do not install this fireplace in a manufactured or mobile home.

3.1 Preparations

Select a wall location in the home plans where all the minimum distances, as shown in Table 2 and Figure 3 can be met. Proceed as follows. Numbers in () are item numbers from Table 1 and Figure 2. Ensure the base on which the fireplace is to be installed is a solid and level foundation and is composed of non-combustible material, such as concrete.

Select a high temperature fire clay or refractory cement and mix according to manufacturer's instructions. Several companies in the U.S. and Canada sell refractory cement or fire clay including Stone Age Manufacturing.

Once the fireplace is constructed you must wait at least 28 days before building a fire to give adequate time to cure. This will provide ample time for any water residue to evaporate, eliminating the adverse reaction of the combination of water and fire.

3.2 Assembly of Components

Components that become broken during shipment and handling can be mortared back together providing the breaks or cracks are clean and the original alignment can be maintained. Components broken into multiple pieces must be replaced.

If this is your first Stone Age installation, it is suggested that you first assemble the components without mortar to familiarize yourself with how the components fit together. See Figure 1.

A. Determine the height off the floor you want to place the base plate (1). The base plate, plus firebrick, will be about 5 ½ inches thick. Set cement blocks under the base plate to obtain the desired height. Note that holes in many pieces of the kit allow the placement of rebar and mortar for additional reinforcement, if desired.

B. When the base is level and square, set the base plate pieces (1 & 1A). Level it from side to side and front to back. See Figure 4.



Figure 4. Base Plate

C. Install the bottom sidewalls (2) first, followed by the bottom back plate pieces (3AL, 3BL, 3CL). On the second level, install the sidewalls (2) first, then the back plates (3A, 3B, 3C), so that the joint lines are offset from the lower level. Use 3/8" joint of mortar between each section. Smooth out mortar and ensure sections remain level. Continue with third level, with sidewalls (2) and back plate pieces (4A, 4B, 4C) See Figures 5, 6 and 7.



Figure 5. Bottom Back Plates & Sidewalls

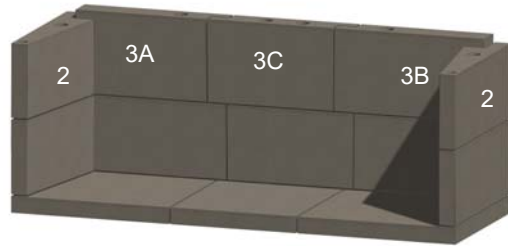

Figure 6. Lower Back Plates & Sidewalls

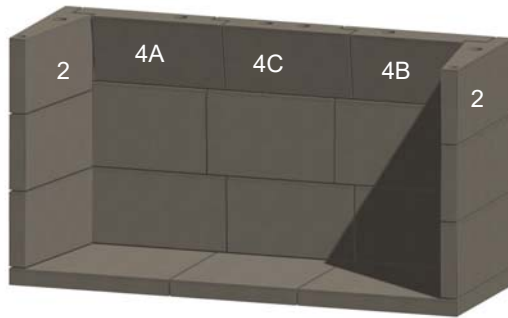

Figure 7. Middle Back Plates & Sidewalls

D. Lay a straightedge across the left and right sidewall to ensure plumb and level are maintained.

E. Install the slanted sidewalls (6 and 7), and the upper back plates (5A, 5B, 5C). Check the sides and the top with a level. See Figure 8.



Figure 8. Upper Back Plates & Sidewalls

F. After installation of the back plates and sidewalls, install the firebrick inside the firebox, using 1/8-inch mortar joints. Cover the floor first with 1/8-inch high temperature cement. On the side walls, stand the brick on its sides, and on the back wall, lay the brick flat, leaving 1/2-inch air space between the firebrick and fireplaces walls. Stack brick until it is flush with the tops of pieces 5A, 5B, 6 and 7. See Figures 9 and 10.

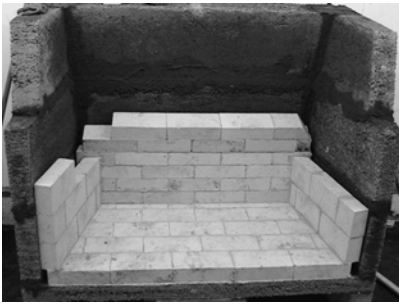

Figure 9. Firebrick Installation

(8). Mortar damper in place. Ensure the damper opens and closes properly.

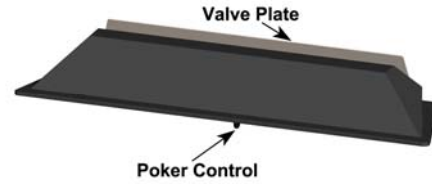

Figure 12. Damper

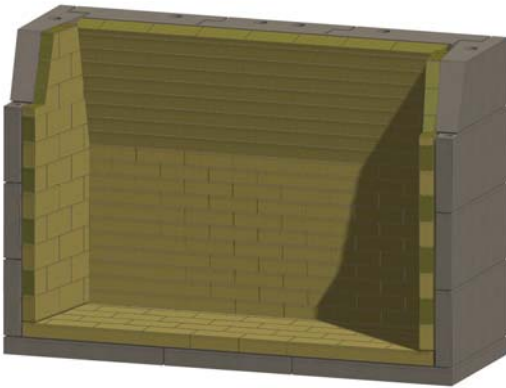

Figure 10. Firebrick Completed

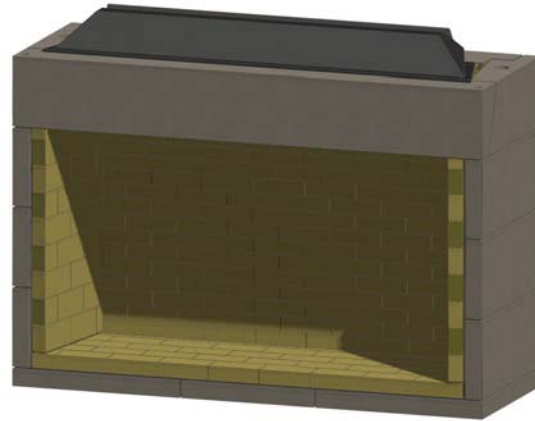

Figure 13. Damper Placement

G. After fire brick installation is complete, install the front lintel (8).

I. Install the first complete ring of four interlocking throat components (items 9, 9C, 10, 11, 11C and 12). Check with a level. See Figure 14.

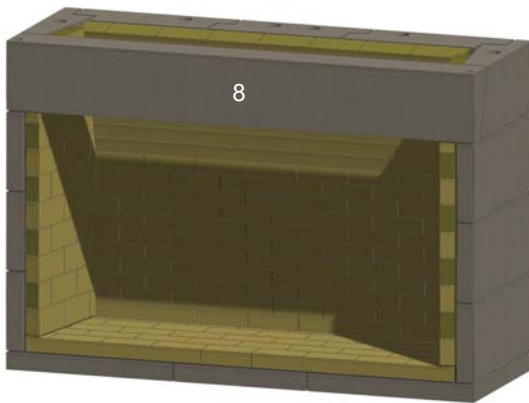

Figure 11. Front Lintel

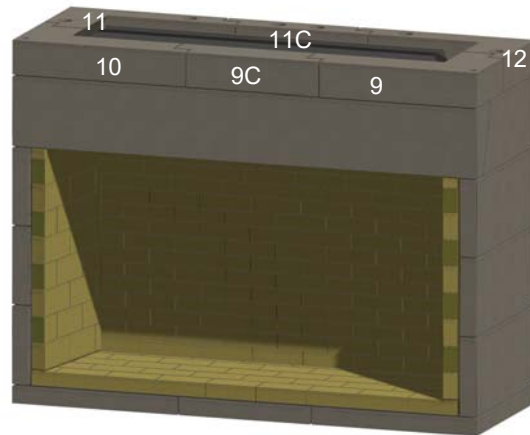

Figure 14. Lower Throat Level

H. Install the cast iron damper. See Figures 12 and 13. Attach poker handle through damper to damper door. Set damper on top of firebox with handle facing toward front of the fireplace. The bottom lip of the damper should rest on the firebrick with the front lip resting on the front header

J. Install second ring of four throat components (Items 13, 14, 14C, 15, 16 and 16C). Check with a level. See Figure 15.

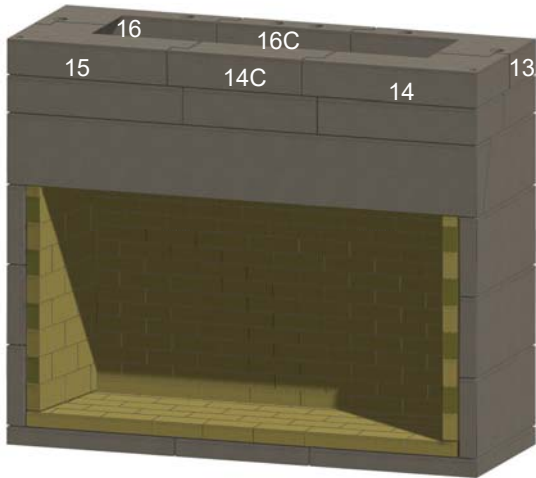

Figure 15. Middle Throat Level

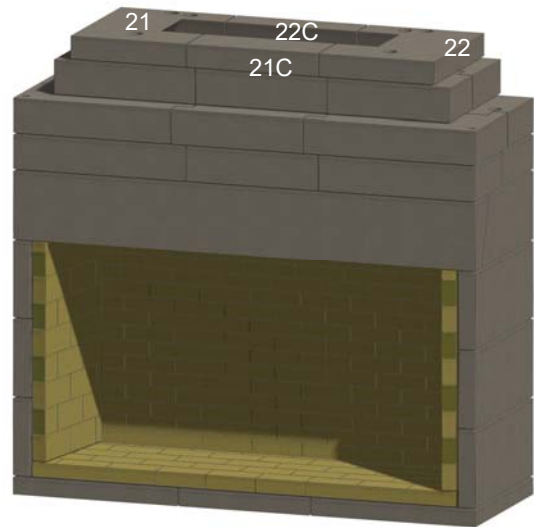

Figure 17, Throat Cap

K. Install the first smaller ring of the upper throat components, consisting of items 17, 18, 18C, 19, 20 and 20C. Ensure the ring is centered. See Figure 16.

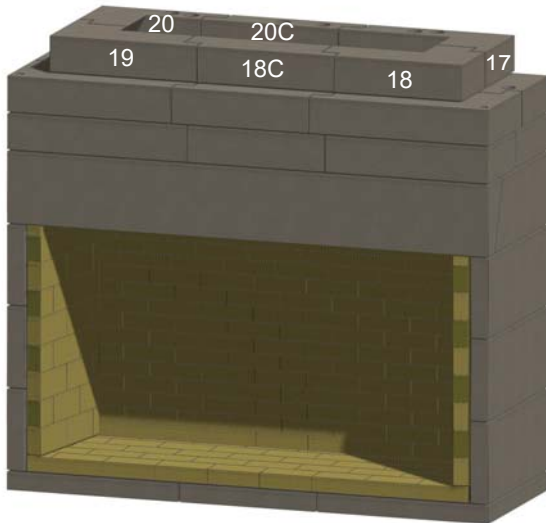

Figure 16. Upper Throat Level

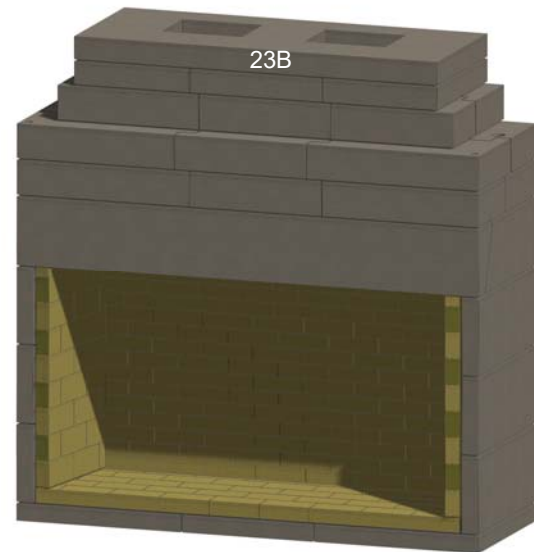

Figure 18, Double Flue Adapter

L. Install the throat cap pieces, items 21, 21C, 22 and 22C, followed by the double flue adapter, item 23B. See Figures 17 and 18.

M. Install Stone Age masonry chimney system, consisting of clay liners and outer blocks, or Stone Age Pipe Adapters if installing a metal pipe chimney. See Figures 19 and 20.

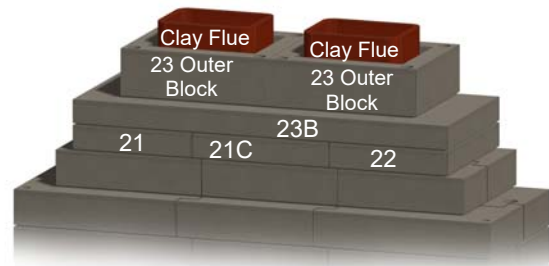

Figure 19. Stone Age Masonry Chimney

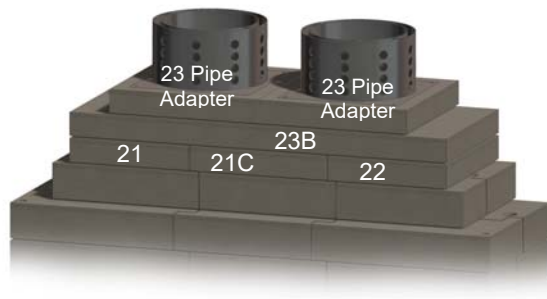

Figure 20. Metal Pipe Chimney

N. If installing a mantel and side trim, especially if it is wood or other combustible materials, ensure that the minimum distances shown in Table 2 and Figure 2 are met.

O. Install the hearth and or hearth extension. Ensure the Table 2 and Figure 3 clearances and distances are maintained. Ensure that the hearth and flooring under and in front of the hearth are made of fully non-combustible materials, not just a non-combustible floor covering. When the hearth installation is complete, you are now ready to install the exterior.

3.3 Exterior finishing

The exterior finish of an indoor fireplace will vary as compared to an outdoor application and may be limited depending on location in the home and framing that encompasses the fireplace. Mantle and exterior veneers may be fabricated stone, thin veneer or full bed depth natural stone, tile, brick or stucco.

If the exterior finish is going to be stucco, stain, tile or manufactured thin stone wrap outside of firebox with metal lathe. Attach metal lathe to firebox using concrete nails, tapcons, masonry or concrete anchors. Natural stone, full bed depth or thin veneer, full size brick, concrete pavers, CMU block, etc. do not require metal lathe.

Ensure same refractory mortar is used.

4.0 Installation of Chimney

Either one of two types of chimney may be installed, the Stone Age masonry chimney system consisting, of proprietary outer blocks and clay flues, or metal pipe chimney pipe tested and certified to UL 103 standards for the US and ULC S604 standards for Canada.

4.1 Stone Age Masonry System

The Stone Age Masonry chimney system consists of stacking Stone Age chimney blocks and installing a clay flue inside. The New Age 60" and 72" use a dual flue, with two blocks and flue, side by side.

A. Place a clay flue inside the chimney block. The holes in each corner of the chimney block allow the placement of rebar and mortar for additional reinforcement, if desired.

B. Continue with stacking the outer blocks and clay flues until the desired height is reached. Mortar the flue sections together, and mortar the chimney block sections together. There will be dead air space between the flue and chimney block sections. See Figure 21.



Figure 21. Masonry Chimney Assembly

C. The chimney is completed by stacking as many flue sections as necessary to reach chimney height. Chimney plumbing can either be straight through the ceiling and through the roof, or if the fireplace is installed on an outside wall, the chimney can be external to the house. When needed offset blocks can be used for the chimney and should be engineered to structurally support the offset with CMU or custom fabricated steel post and or angle iron capable of supporting the weight and height of the chimney. Never exceed more than a 30 degree angle when offsetting a chimney. See Figure 22.

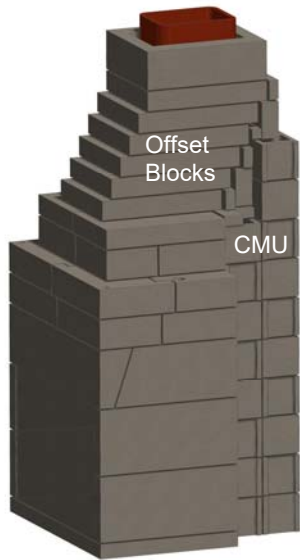

Figure 22. Offset Blocks and CMU Support

D. Dual masonry chimneys taller than 12 feet should be tied into the surrounding structure for additional support, due to the weight of the dual flue system. Consult with an engineer to determine the best way to do so for your project.

E. If chimney exit opening does not already exist locate the point where the chimney will exit the roof by plumbing down to the center of the fireplace chimney. Drive a nail into the roof to mark the center.

F. Measure to all sides of the nail and mark the required opening, and then cut a hole in the roof. Remember that the hole is measured on the horizontal, and then projected to the roof. The hole may then be larger, depending on the pitch of the roof. See Figure 23.

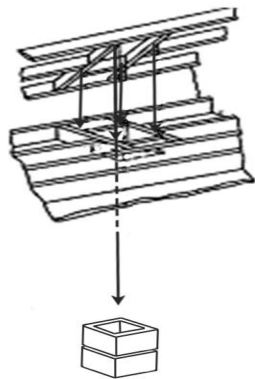

Figure 23. Roof Penetration

G. Frame the opening in the roof.

H. Continue to add flue sections, extending the chimney through the roof.

I. Install roof flashing appropriate to the roof pitch.

J. Use mortar to create a slope away from the clay flue, running out to the edge of the finish material, to assist with water drainage. Install the chimney cap following instructions provided. This will protect the chimney from rain, birds, animals and leaves. See Figure 24.



Figure 24. Install Chimney Cap

4.2 Metal Chimney

Install the metal chimney following the instructions below and the instructions provided by the chimney pipe manufacturer.

Install two Stone Age masonry pipe adapters (sold separately) to the top of the firebox, using 14" I.D. adapters for the NA 60. Connect the first pipe sections to the metal adapters as shown in Figure 25. Chimney plumbing can either be straight through the ceiling and through the roof, or if the fireplace is installed on an outside wall, the chimney can be external to the house. Affix warning labels to the pipe. See Figure 25.

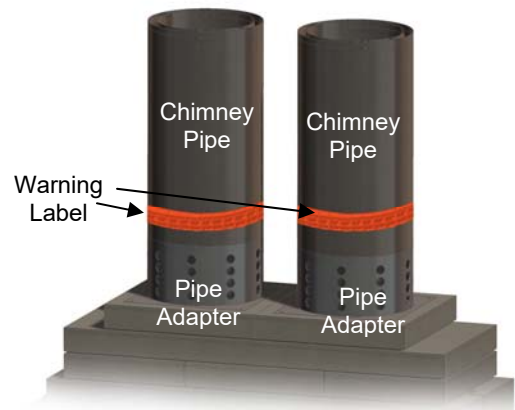

Figure 25. Connect Chimney

A. When the chimney passes through a ceiling to an upper floor, ensure the chimney pipe manufacturer's recommended clearances to combustibles is maintained with framing where it passes through the ceiling.

B. Complete chimney installation as shown in Figure 26. As the chimney extends through the attic to the roof, attach securing straps to rafters and joists as required to provide stability.

C. As the chimney rises through the ceiling, perhaps a second floor, and through the attic and roof, 16 inches or 30 degrees is the maximum offset allowed, and only one offset is permitted.

D. If chimney exit opening does not already exist, locate the point where the chimney will exit the roof by plumbing down to the center of the chimney. Drive a nail into the roof to mark the center.

E. Measure to all sides of the nail and mark the required opening, and then cut a hole in the roof. Remember that the hole is measured on the horizontal, and then projected to the roof. The hole may then be larger, depending on the pitch of the roof. See Figure 23.

F. Frame the opening, ensuring that the recommended minimum clearance to combustibles by the chimney pipe manufacturer exists between the roof and the chimney, ensuring that distance is maintained all the way around.

WARNING: DO NOT PACK REQUIRED AIR SPACES WITH INSULATION OR OTHER MATERIALS.

G. Continue to add pipe sections, extending the chimney through the roof.

H. A wood chase may be constructed around the exposed chimney for aesthetic effect. Ensure the minimum recommended clearances to combustibles specified by the metal chimney pipe manufacturer are maintained inside the chase.

I. Install roof flashing appropriate to the roof pitch, and any other pipe accessories, per the pipe manufacturer's instructions.

J. Install the appropriate chimney cap for the pipe being used.

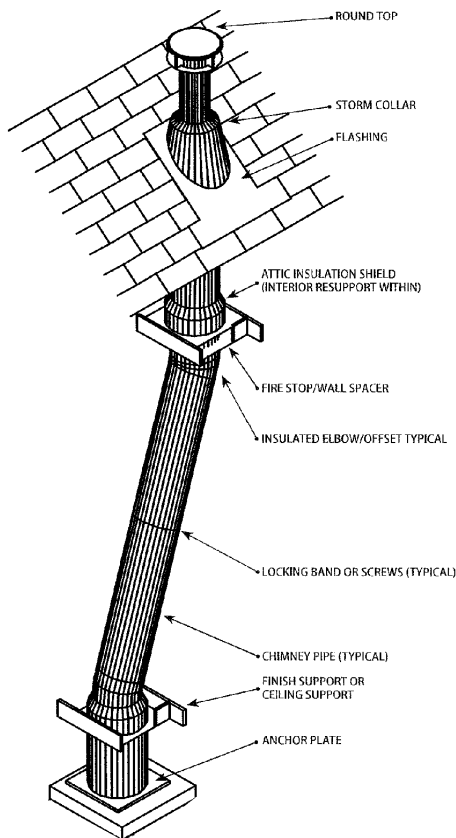

Figure 26. Metal Chimney Construction

4.3 Height of Chimney – Metal or Masonry

Figure 27 illustrates the proper height of the chimney top. Correct height depends on the chimney's location on the roof and distance from the peak of the roof. Surrounding trees, other buildings and hills may also be a consideration.

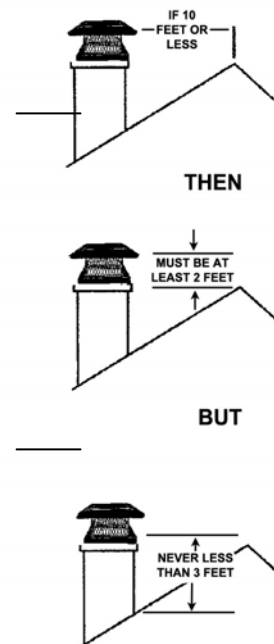

Figure 27. Chimney Height

If the chimney top is not high enough, unusual downdrafts may occur, resulting in undesired smoke spillage. For a more thorough explanation of the figure 27 illustration, this is the traditional 2/10 rule. The center of your chimney should be a minimum of two feet higher than any roof or projection within ten feet horizontally from the chimney center. This means the chimney does not have to extend above the peak of the roof. Once the chimney is ten feet away and extended two feet above roof structure at that distance, the height is sufficient, but it should never be less than three feet taller than the point where it penetrates the surface of the roof.

5.0 Operating Instructions

5.1 Safety Precautions

A fireplace can bring many hours of enjoyment, comfort and warmth if operated and maintained properly. Certain safety precautions must be observed to eliminate the dangers associated with fire and provide a satisfactory, smoke free fire.

A. When burning wood use solid, seasoned wood only. Do not use scrap wood or artificial wax based logs, treated coal or woods dipped in pine tar or pitch.

B. Never use gasoline or other combustible liquids when starting a fire.

C. Keep the chimney damper open while burning a fire. Do not interrupt air flow. Ensure sufficient air is present to support combustion. **The manufacturer of this fireplace is not responsible for interior smoke resulting from lack of combustion air.**

CAUTION: WHEN USING THE DECORATIVE GAS APPLIANCE (VENTED GAS LOGS); THE FIREPLACE DAMPER MUST BE SET IN THE FULLY OPEN POSITION.

D. Keep a screen in front of the fireplace except when tending the fire.

E. Keep combustible furniture/pillows at least four feet from the opening.

F. Never leave the fire unattended.

G. Be extremely careful when adding wood and handling fireplace tools. Never throw, kick or by any other means force wood into the firebox as this

could damage the firebrick and fireplace walls that could result in permanent damage and void the warranty. Stress cracks from thermal cycling are normal.

H. Do not alter this fireplace to the extent that it would jeopardize the structural integrity of the fireplace. Drilling or cutting a hole for a gas line, fresh air vent or ash dump is acceptable. Use only Stone Age authorized equipment with this fireplace.

5.2 Selection of Wood

Use cured wood logs only. Scrap wood produces sparks. Treated wood, coal, or woods dipped in pine tar should not be used because they may leave a combustible residue in the fireplace and chimney.

Use of seasoned wood is preferred.

The amount of heat available from logs will depend on the type of wood, its dryness, quantity of wood and the size of the logs. Ten pounds of twigs will produce as much heat as a 10 pound log, but will produce it much faster because the air supply is more available.

5.3 Softwood vs. Hardwood

Wood is divided into two classes, hard and soft woods. Each has a use in a fireplace and each has advantages and disadvantages.

The hardwood category includes such woods as oak, walnut, birch, elm and maple. Softwoods include pine, fir, cedar and spruce.

Selection of wood depends on the type of fire you want. Softwoods are good to offset a morning chill because the fire develops faster. Hardwoods are preferable for a slower burning and uniform heat output.

Softwoods contain a highly flammable resin that will leave creosote soot in the chimney flue. This often results in sparking. Burning softwood exclusively will require more frequent inspection and cleaning of the chimney.

Experienced fire builders often use small amounts of softwood kindling and newspaper when starting a split hardwood log fire.

5.4 Seasoned Wood

Most freshly cut "green" wood will not burn well and will smoke. The pressure of moisture and resin inside green wood will build under heat and explode

as sparks. Therefore, it is recommended that only seasoned wood be used in your fireplace.

Most wood requires 9 to 12 months of seasoning and drying to reduce the moisture content enough to produce good steady fires. Ensure that you buy only seasoned wood, or if you buy green wood (usually cheaper), store it properly to aid in the seasoning process. The following steps will assist in the seasoning process.

- A. Stack wood loosely to permit maximum air circulation.
- B. Do not stack wood on the ground. Use a wood rack or stack on scrap lumber. Storage on the ground will cause rotting and insect infiltration.
- C. Cover wood stacks with a tarp so that it is not excessively exposed to the elements such as snow and rain.
- D. Do not stack wood against the walls of your home.

5.5 Building a Fire

A. Use a log grate (sold separately) with your fireplace. This will contribute to good air circulation around the wood, and keep the wood out of the ash. This grate is shown in Figure 28.



Figure 28. Log Grate

B. Close windows located near the fireplace when first lighting a fire to reduce the possibility of smoking. It can be reopened once a draft has been created through the chimney.

WARNING: NEVER USE GASOLINE, GASOLINE-TYPE LANTERN FUEL, KEROSENE, CHARCOAL LIGHTER FLUID OR SIMILAR LIQUIDS TO START OR “FRESHEN UP” A FIRE IN THE FIREPLACE. KEEP ALL SUCH LIQUIDS WELL AWAY FROM THE FIREPLACE WHILE IT IS IN USE.

C. Do not overload the wood grate with wood. Three to four logs on the fire at one time are sufficient. Too much wood on the fire at one time can result in “over firing,” and too much heat in the firebox, causing damage to the fireplace.

D. When lighting a fire in a cold chimney, a downdraft may be created, letting a little smoke into the room. To correct this, hold a wadded newspaper in the firebox and light it. This will create an updraft and clear the flue of cold air.

The following steps are recommended when starting a fire.

A. Remove any excess ash from the fireplace. Excessive ash may reduce airflow. Some owners prefer to leave a small layer to insulate the cold refractory brick below the grate, helping fire starting.

B. Open and close the damper to ensure it operates properly. Leave it in the full open position when starting a fire and while the fire is burning.

C. Center the grate over the bottom hearth of the firebox.

D. Crumble several newspapers across the fire area underneath the grate. Criss-cross kindling wood on top of the grate, above the newspaper.

E. Lay three logs on the grate; two side by side and the third in pyramid fashion on top. Split logs will start faster. Ensure there is space between the logs for air circulation. As the air is heated, it is drawn upwards through the space between the logs, creating more combustion.

F. Light the paper at both sides of the firebox.

Caution: The fireplace requires air for operation. Ensure there is sufficient air so that other fuel burning appliances are not starved of combustion, ventilation, and dilution air.

G. Set the screen in front of the firebox to prevent the escape of sparks and embers.

H. Ensure the fire remains centered in the firebox. Don't let it move to the front part. Move it back with the poker.

I. Add wood to the fire as necessary.

CAUTION: Be extremely careful when adding wood to the fire. Use proper fireplace tools and wear gloves. If adding an unsplit log, it is possible that it may want to roll out.

6.0 Cleaning, Inspection and Maintenance

As is the case with most other equipment, cleanliness is the best maintenance practice and will contribute too many hours of warmth and pleasure.

WARNING: DO NOT CLEAN THE FIRE-PLACE WHEN IT IS HOT.

A. Creosote – Formation and Removal. When wood is burned slowly, it produces tar and other organic vapors, which combine with expelled moisture to form creosote. The creosote vapors condense in the relatively cool chimney flue of a slow burning fire. As a result, creosote residue accumulates on the flue lining. When ignited, this creosote makes an extremely hot fire. The chimney shall be inspected at least twice a year during the heating season to determine when a creosote buildup has occurred. If a significant layer of creosote has accumulated (3 mm or more), it should be removed to reduce the risk of a chimney fire.

B. Disposal of ashes - Ashes should be placed in a metal container with a tight-fitting lid, and taken outside and placed on the ground, well away from all combustible materials, pending final disposal. If the ashes are disposed of by burial in soil or otherwise locally dispersed, they should be retained in the closed container until all cinders have thoroughly cooled.

C. The grate may be removed from the firebox for cleaning. However, ensure it is returned prior to laying the next fire.

D. Keep the fireplace screen clean so air flows freely through it.

E. Spot check the refractory bricks and mortar for small cracks. It will expand slightly with the heat, and then contract as it cools. Replace refractory

bricks when the cracks open more than ¼"; or when pits become extensive and deeper than 3/16"; or when any piece of refractory larger than 2 inches in diameter becomes dislodged.

F. If creosote has accumulated, it should be removed to reduce the risk of a chimney fire. Clean the chimney as outlined below or have the chimney cleaned by a professional chimney sweep.

WARNING: DO NOT USE CHEMICAL CHIMNEY CLEANERS THAT ARE Poured ON A HOT FIRE. THE CHEMICAL CLEANER CAN BE DANGEROUS AND GENERALLY WILL ONLY WORK ON THE FLUE SECTION NEAREST THE FIRE, LEAVING THE REST OF THE FLUE UNAFFECTED.

G. Inspect the top cap and opening in your chimney top and remove any debris that could clog it. If possible, birds will often nest there, and it must be kept clear of nest material.

H. Check the metal flashing and seals around the chimney. Seal any cracks or loose nail heads to prevent roof leaks.

I. Cover the firebox opening with a damp sheet and seal with masking tape to retain soot in the firebox while cleaning.

J. Inspect the entire flue from the top down for obstructions. Use a flexible handled cleaning brush. If the chimney contains offset/return elbows, clean from the top down to the offset, then from the firebox up to the offset.

K. Check the flue from inside the fireplace with the damper open for obstructions.

L. After completion of cleaning, use a vacuum cleaner to remove all soot and residue from the firebox.

Rear View

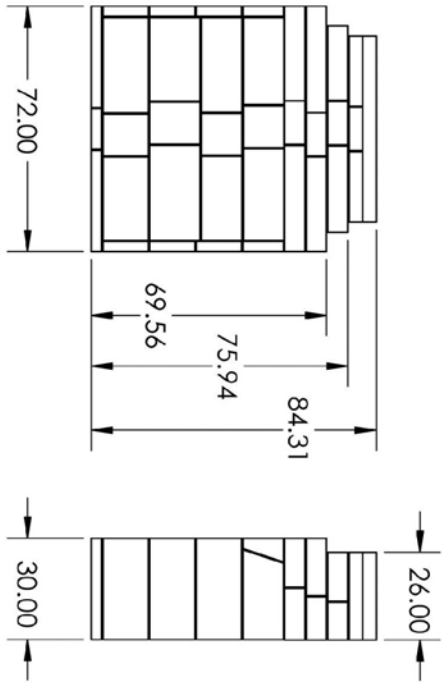

Side View

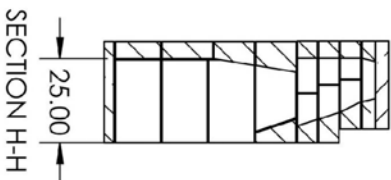

Front View

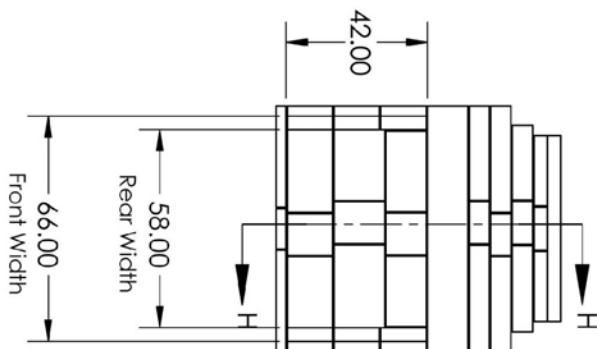

Top View

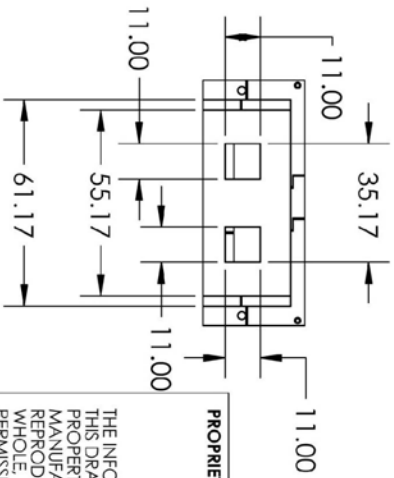

PROPRIETARY AND CONFIDENTIAL
 THE INFORMATION CONTAINED IN THIS DRAWING IS THE SOLE PROPERTY OF STONE AGE MANUFACTURING, INC. ANY REPRODUCTION, IN PART OR AS A WHOLE, WITHOUT THE WRITTEN PERMISSION OF STONE AGE MANUFACTURING, INC. IS PROHIBITED.

UNLESS OTHERWISE SPECIFIED:
 DIMENSIONS ARE IN INCHES
 TWO PLACE DECIMAL ±

MATERIAL

DO NOT SCALE DRAWING

DRAWN

NAME DATE

Stone Age
 Modular Masonry Technology at its Finest
 11107 E 126TH ST. N.
 Collinsville, OK 74021
 918-371-8861

SIZE DWG. NO. REV
A NA60IND-3V

SCALE: 1:48 WEIGHT:

SHEET 1 OF 1

Firebox Widths, without Firebrick

LIMITED WARRANTY

The products of Stone Age Manufacturing, Inc. (“Stone Age”) have been carefully manufactured and the components assembled to give the customer a quality product. Stone Age warrants to the original purchaser the materials that it provides to the customer against defects in manufacture for a period of twenty-five (25) years from the date of purchase on UL-127 listed fireplaces, for a period of five (5) years from the date of purchase on all unlisted fireplaces, fire pits, and other masonry components. Other accessory items or components offered, but not produced by Stone Age Manufacturing, Inc., shall be covered by their manufacturer’s warranties. This Limited Warranty covers only actual manufacturing defects in the Stone Age product and does not cover defects or faulty workmanship in the installation of the product or the masonry or other structure in which it is installed. Also this warranty does not cover items that have been damaged due to over-heating, modification, improper storage or maintenance. Stone Age shall repair or replace, at its option, any defective Stone Age product component upon receipt of written notice addressed to Stone Age. This Limited Warranty covers only replacement of any defective components within the product itself occurring during the warranty period and does not cover the cost of installation or removal from a fixed location. NO OTHER WARRANTIES, EXPRESS OR IMPLIED, ARE MADE, INCLUDING IMPLIED WARRANTIES OF MERCHANTABILITY AND FITNESS FOR PARTICULAR PURPOSES WHICH ARE SPECIFICALLY DISCLAIMED. Stone Age is not liable for damages or injury to persons or property or other incidental or consequential damages.

Stone Age Manufacturing, Inc.
11107 E. 126th St. N., Collinsville, OK 74021
WWW.Stoneagefireplaces.com