

Installation and Operation Instructions Stone Age Outdoor Fireplace

Ce manuel est disponible en français à www.stoneagemanufacturing.com.
This manual is available in French at www.stoneagemanufacturing.com.

1.0 Introduction

The following provides instructions for the installation and operation of the Stone Age Fireplace, manufactured by Stone Age Manufacturing, Collinsville, Oklahoma.

Three generations of fireplace knowledge and experience have gone into the design and construction of the Standard series fireplaces. Standard Fireplaces are certified to UL127 for the US, and ULCS610 for Canada.

Assembly and Cutaway views of a SA36 fireplace are shown in Figure 1.

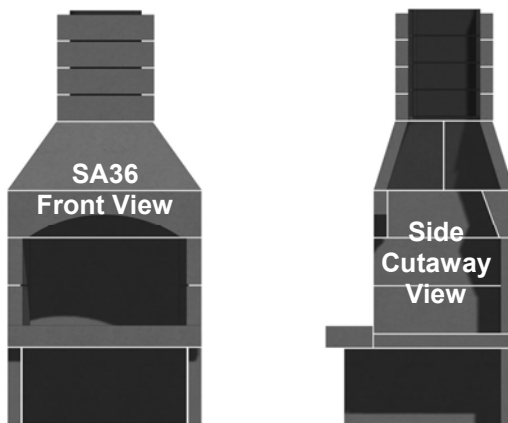

Figure 1. SA36 Fireplace Assembly & Cutaway View

Because of structural modifications required in an existing home, it is recommended that this fireplace be installed by a professional installer, or by a builder in new construction. Installation by a non-qualified person may negate the warranty.

Keep these instructions for future reference.

2.0 Description

The fireplace is delivered as a kit with all components necessary to complete the installation. Component arrangements are shown in Figure 2. Components are listed in Table 1. Specifications and installation dimensions are shown in Table 2.

A completed installation should include the following:

- A. Fireplace items shown in Figure 2 and listed in Table 1.
- B. Top Mount Damper (Optional for Outdoor installations, sold separately) (Shown in Figure 28).
- C. Chimney Cap (sold separately) (Shown in Figure 26).
- D. Fireplace Grate (sold separately) (Shown in Figure 31).
- E. Split firebrick (may be included or sold separately - confirm with your dealer)
- F. Stone Age Multi-Purpose Ready-Mix Cement (sold separately).

The Stone Age Fireplace has been tested and listed in accordance with UL 127 and ULC S610 standards for indoor or outdoor use, and is listed by OMNI-Test Laboratories, Inc. for installation and operation in the United States and Canada as described in this manual.

This fireplace is designed to supplement your current heating system. It is not designed to be used as a primary heat source.

Ensure that appropriate building permits required by local codes are obtained before installation in an existing home.

2.1 Specifications

Table 2: Clearances (See Figure 3)

Item	Clearance	Figure 3 Reference
Sidewall to Opening	18"	
Top Trim to Opening	17"	A
Side Trim to Opening	3"	
Mantle to Opening	25"	B
Floor to Opening	7"	
Front Hearth Extension	24"	C
Side Hearth Extension	12"	D
Opening to Combustibles	48"	
Minimum Ceiling Height	7'6"	
Clearance around Chimney flue	2"	
Chimney Height from floor	16'	
Note 1: This Fireplace is intended for use with solid wood fuel or vented gas logs		
Note 2: This fireplace has not been tested for use with glass doors. To reduce the risk of fire or injury, do not install glass doors.		
Note 3: Do not use fireplace insert or other products not specified for use with this model. Use a fireplace grate when burning wood.		
Note 4: This fireplace has not been tested with an unvented gas log. Do not install an unvented gas log set into this fireplace.		
Note 5: Clay flue liners installed in flue section (item 9A, Figure 2) meet the specifications of ASTM Section C315-02.		
Note 6: Make sure installation complies with local building codes.		
Note 7: Thermal Floor Protection of ½" of k=0.84 thermal protection		
Note 8: Floor under unit must be non-combustible to earth		

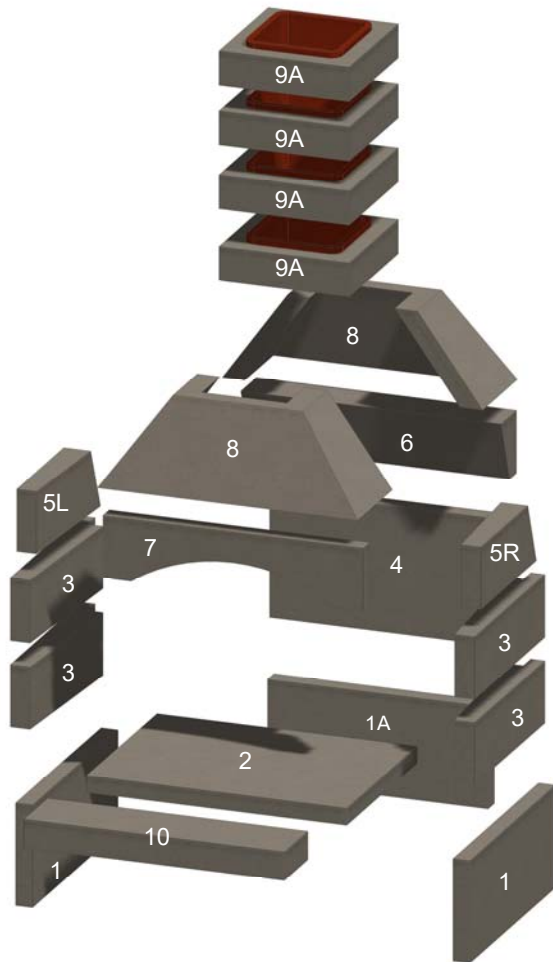

Figure 2. Fireplace Components

Table 1. Fireplace Components

Item	Description	36"
1	Riser Legs	18 x 40
1A	Riser Leg-Cross	18 x 39
2	Base Plate	33 x 46
3	Sidewall	11 x 33
4	Back Plate	22.5 x 40
5L/5R	Slanted Sidewall	11 x 26
6	Back Header	11 x 46
7A/7S	Lintel, Arch/Straight	11 x 46
8	Throat	23 x 23 at top
9A	Flue (Note 2)	22 sq
10	Hearth	11 x 5 x 46
Note 1: Item numbers refer to component numbers in Figure 1.		
Note 2: Flue sections are available but not provided in sufficient quantity to reach a height of 16 feet. Flue sections must be purchased separately.		

Note: Drawings of the fireplace components, with dimensions, are shown on page 15.

Note 1: This Fireplace intended for use with solid wood fuel or vented gas logs.

CAUTION: When using this appliance, the fireplace damper (if present) must be set in the fully open position.

Note 2: This fireplace has not been tested for use with glass doors.

Note 3: Do not use fireplace insert or other products not specified for use with this model. Use a fireplace grate when burning wood.

Note 4: Clay flue liners installed in flue section meet the specifications of ASTM Section C315-02.

Note 5: Ensure installation complies with local building codes.

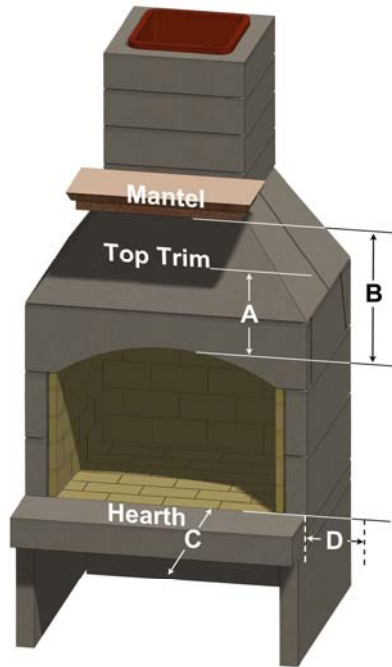

Figure 3. Clearances (Use with Table 2)

2.2 Installation of Additional Equipment

WARNING: THIS FIREPLACE HAS NOT BEEN TESTED FOR USE WITH DOORS. TO REDUCE THE RISK OF FIRE OR INJURY, DO NOT INSTALL GLASS DOORS.

A. Do not install a fireplace insert unless it is tested with this fireplace.

B. Cutting or drilling a hole into the floor or walls for gas supply for a vented decorative gas appliance (log), fresh air venting, or an ash dump, is acceptable.

C. If a decorative gas appliance is installed, it must be installed in accordance with the National Gas Fire Code, ANSI Z223.1.

D. It must incorporate an automatic shutoff device.

E. Installation must comply with the Standard for Decorative Gas Appliances in Vented Appliances, ANSI Z21.60 (1991) or American Gas Association draft requirements for Gas-Fired Log Lighters for Burning Fireplaces, Draft No. 4 dated August 1993.

3.0 Installation of the Fireplace

WARNING: DO NOT USE SUBSTITUTE MATERIALS IN THE ASSEMBLY, INSTALLATION OR OPERATION OF THIS FIREPLACE. TO DO SO WILL VOID THE WARRANTY AND MAY RESULT IN FIRE AND PERSONAL INJURY.

It is most important that the Stone Age fireplace be installed according to the following instructions. It is also important that local building codes be consulted and followed. Improper installation could result in:

- Overheating, leading to fireplace failure
- Leakage of rainwater through and around the chimney
- Cracks and settling because of poor foundations
- Emission of smoke, sparks and gases into the living area
- Combustion of materials adjacent to the fireplace.

WARNING: THIS FIREPLACE HAS NOT BEEN TESTED WITH AN UNVENTED GAS LOG SET. TO REDUCE THE RISK OF FIRE OR INJURY, DO NOT INSTALL AN UNVENTED GAS LOG SET INTO THIS FIREPLACE.

Do not install this fireplace in a manufactured or mobile home.

3.1 Preparations

Select a location in the home plans or outdoor living area where all the minimum distances, as shown in Table 2 and Figure 3 can be met. Proceed as follows. Numbers in () are item numbers from Table 1 and Figure 2. Ensure the base on which the fireplace is to be installed is a solid and level foundation and is composed of non-combustible material, such as concrete.

Due to varying climates, soil conditions, building codes, construction methods and materials in different geographical regions, Stone Age recommends installers review local building codes, consult with local building officials and/or a structural engineer before beginning the construction of any Stone Age product.

Pad or footings for outdoor installations should be a monolithic pad constructed of steel reinforced concrete. Minimum footing specifications for fireplaces built on stable soil, with overall height not exceeding 10 feet, are listed in Table 3. Locations with unstable soil may require a deeper footing or the addition of piers, to reach more stable subsoil or bedrock. Areas with colder climates may also require deeper footings or piers that reach below the frost line to prevent frost heaving. Piers should include steel reinforcement that extends into the footing above. See Figure 4.

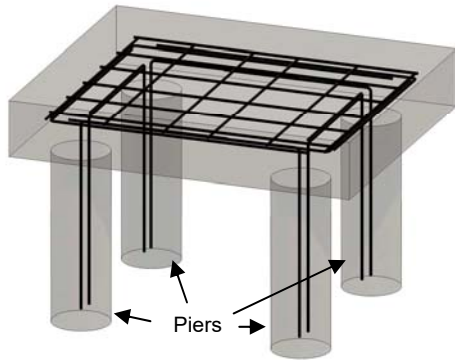

Figure 4. Footing with Piers - Cutaway View

For taller applications, consult with an engineer to determine the structural requirements based on the overall height, and the weight of fireplace, chimney, and finish materials. If custom hearths or additional masonry structure is to be attached to the fireplace kit, the footing dimensions should be adjusted to include these customizations.

If local building code exceeds the manufacturer's specifications for footings, follow the local code.

Table 3. Minimum Footing Specifications

Minimum Requirements for Footing		36"
Thinner Finishes- Fabricated Stone, Stucco, Stain or Tile	A	6" - 8"
	B	48"
	C	52"
Thicker Finishes- Full Veneer Natural Stone or Brick	A	12" - 18"
	B	54"
	C	58"
See Figure 5.		

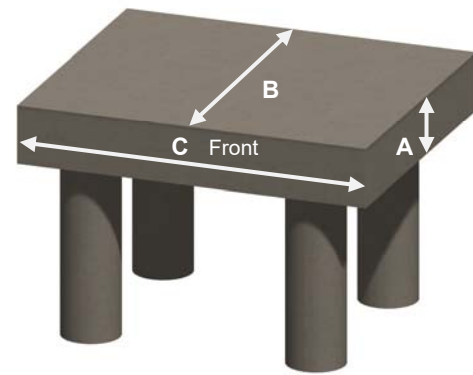

Figure 5. Footing with Piers

Footing requirements for indoor installations should be determined based on local building code. Consult with a structural engineer to determine the footing requirements based on the overall height, and the weight of fireplace, chimney, and finish materials. If custom hearths or additional masonry structure is to be attached to the fireplace kit, the footing dimensions should be adjusted to include these customizations.

Use Stone Age's Multi-Purpose Ready-Mix, or another high temperature fire clay or refractory cement suitable for indoor or outdoor use, and mix according to manufacturer's instructions.

Once the fireplace is constructed you must wait at least 28 days before building a fire to give adequate time to cure. This will provide ample time for any water residue to evaporate, eliminating the adverse reaction of the combination of water and fire.

Stone Age products are designed to be assembled using a 3/8" fully bedded mortar joint for the kit pieces. Do not "butter the edges" of the kit pieces.

If the unit is to be installed indoors, do not use the Riser Legs (items 1 and 1A, shown in Figure 2 and Table 1). Instead, install the fireplace on a solid base, such as a cement pad or concrete blocks. Two courses of 8" tall block will be slightly shorter than the riser legs of the kit.

WARNING: DO NOT USE RISER LEGS FOR AN INDOOR INSTALLATION. IN THIS INSTALLATION, THE VOID BELOW THE FIREBOX COULD INADVERTANTLY BE USED FOR THE STORAGE OF COMBUSTIBLE MATERIALS, WHICH COULD CREATE A FIRE HAZARD.

3.2 Assembly of Components

Components that become broken during shipment and handling can be mortared back together providing the breaks or cracks are clean and the original alignment can be maintained. Components broken into multiple pieces must be replaced.

If this is your first Stone Age installation, it is suggested that you first assemble the components without mortar to familiarize yourself with how the components fit together. See Figure 2.

During the actual assembly with mortar, ensure each layer of the kit is plumb, level, and square before proceeding to the next step of the assembly.

A. For Indoor installations, determine the height above the floor you want to place the base plate (2). The base plate, plus firebrick, will be approximately 4 1/2 inches thick. Mortar and set concrete blocks into place to reach the desired height. Ensure the block base is level and square. Set the base plate (2), ensuring it is level and square. See Figures 6 & 7.



Figure 6. Block Base For Indoor Use



Figure 7. Kit Base Plate

B. For Outdoor installations, align and set a Riser Leg (1) and the Cross Leg (1A) on the footing, ensuring they are plumb and level. See Figure 8.



Figure 8. Riser Leg & Cross Leg

C. Install the second Riser (1), ensuring it is plumb, level and square. See Figure 9.



Figure 9. Riser Legs & Cross-Leg

D. Set the base plate (2), ensuring it is level and square. See Figure 10.



Figure 10. Base Plate

Note 6: From Step E to Step Q, the installation procedure will be the same for indoor or outdoor applications.

E. Install the lower sidewalls (3), ensuring they are level and square. See Figure 11.

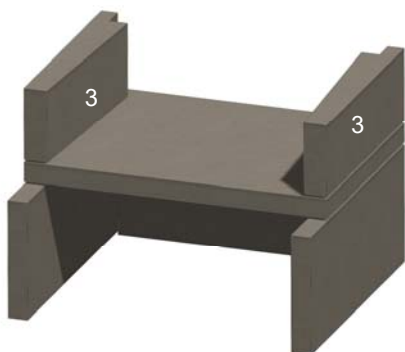

Figure 11. Lower Sidewalls

F. Install the middle sidewalls (3), ensuring they are level and square. See Figure 12.

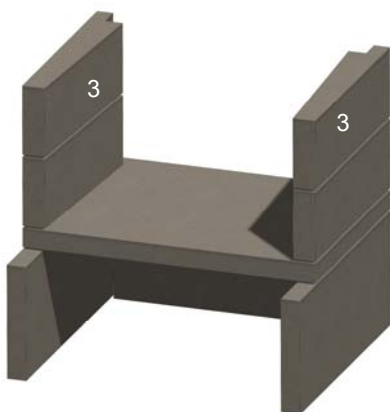

Figure 12. Middle Sidewalls

G. Install the back plate (4). See Figure 13.



Figure 13. Back Plate

H. Install upper sidewalls (5L) and (5R), ensuring the correct piece is placed in position. The correct position is when the inner wall, outer wall and front are parallel with the middle wall pieces. Place each so the front is set back 3½ inches from the front of the middle wall piece below. See Figures 14 & 15.

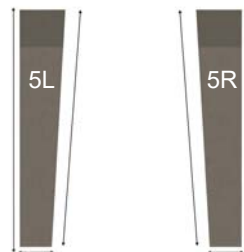

Figure 14. Upper Sidewalls -Top View

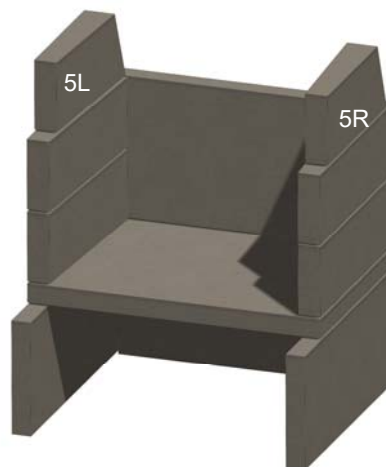

Figure 15. Upper Sidewalls

H. Install Back Header (6). See Figure 16.

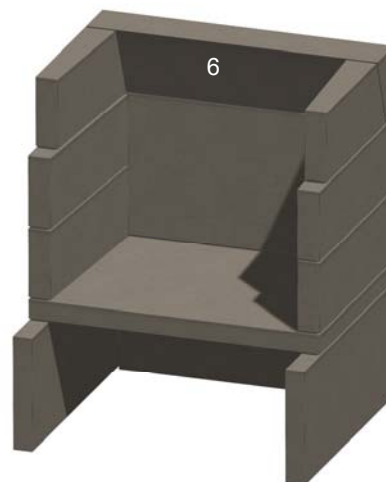

Figure 16. Back Header

I. Line the firebox, using split firebrick and 1/4-inch mortar joints. Install firebrick on the floor first, with 1/4-inch of Stone Age Multi-Purpose Ready-Mix or other high temperature mortar. See Figure 17.

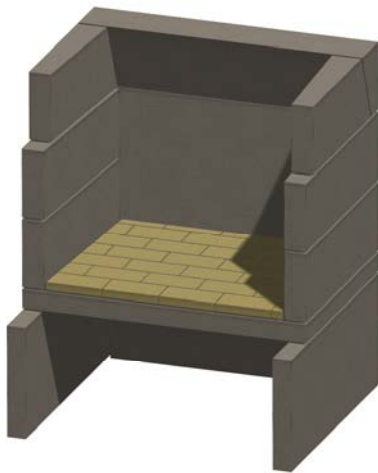

Figure 17. Floor Firebrick

K. Install firebrick on the side walls, with the brick laid on edge. The brick lay up on approximately 1/3 of the upper sidewall, and a notch should be cut in the front brick on each side, to allow them to clear the front lintel piece (to be installed later). See Figure 19.

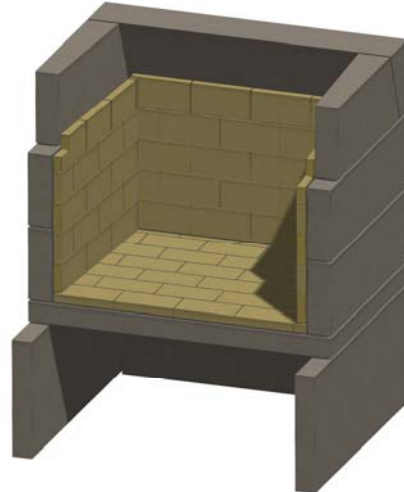

Figure 19. Sidewall Firebrick

J. Install firebrick on the back wall, with the brick laid on edge. See Figure 18.

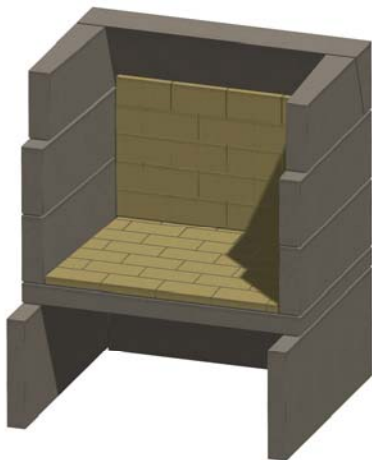

Figure 18. Back Wall Firebrick

L. Install the front lintel piece, (7A, for arched lintel, as shown) or (7S, for straight lintel kits). See Figure 20.

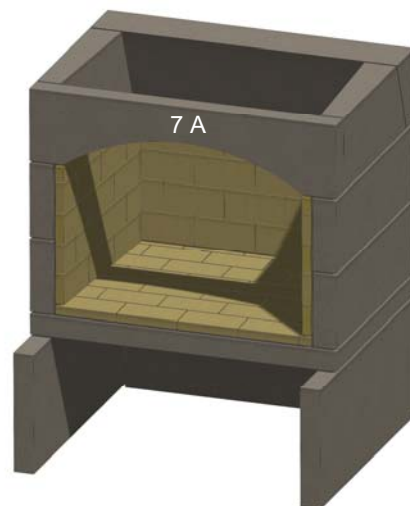

Figure 20. Front Lintel

M. Install the tapered front and rear throat pieces. See Figure 21.

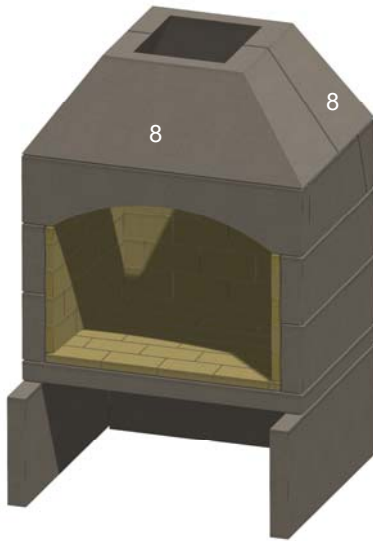

Figure 21. Throat Pieces

N. Install the first Stone Age masonry chimney section (9A), with the tile extending upward. Fill the void on the bottom with mortar to create a smooth transition. See Figure 22.

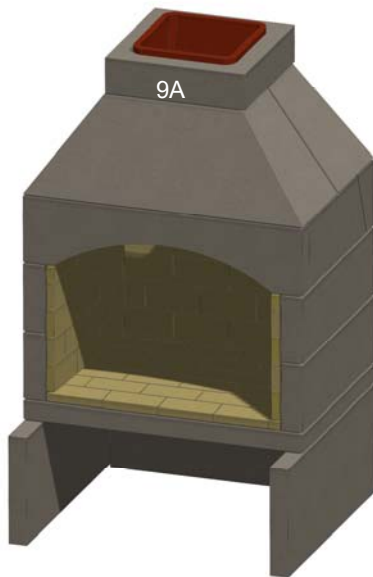

Figure 22. Chimney Flue

O. Install the remaining chimney sections (9A), fully bedding each piece in mortar, and filling in the gap between the clay tiles in each section. Parge the joints to create a smooth transition between each chimney section. Note that if a tile is chipped or

slightly out of square, it may be used as long as it the joints are filled and smoothed with high temperature mortar. See Figure 23. **If additional chimney is required to penetrate a roof or structure, refer to Section 4.0 for more detailed instructions.**

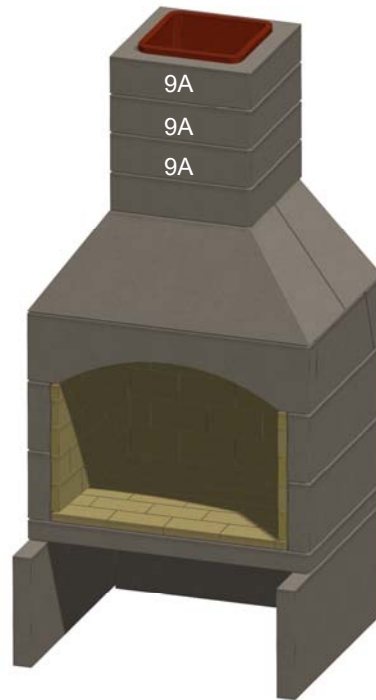

Figure 23. Chimney Complete

P. Install the hearth piece (10) if using this component, and any hearth extension. See Figure 24.



Figure 24. Hearth

Q. Ensure the Table 2 and Figure 3 clearances and distances are maintained. Ensure that the hearth and flooring under and in front of the hearth are made of fully non-combustible materials, not just a non-combustible floor covering. When the hearth installation is complete, if the chimney complete and is not continuing through a roof or structure, you are ready to install the exterior finish. If the chimney will be continuing through a roof or structure proceed to Paragraphs 4.0 and 4.1 before beginning the finish application.

If installing a mantel and side trim, particularly if it is wood or other combustible materials, ensure the minimum distances shown in Table 2 and Figure 3 are met.

3.3 Exterior finishing

The exterior of the fireplace may be finished in any masonry-compatible material. Mantle and exterior veneers may be fabricated stone, thin veneer or full bed depth natural stone, tile, brick or stucco.

If the exterior finish will be stucco, stain, tile or manufactured thin stone, wrap the outside of the firebox with metal lathe. Attach metal lathe to the firebox using concrete nails, tapcons, masonry or concrete anchors. Natural stone veneers (whether full bed depth or thin veneer), full size brick, concrete pavers, CMU block, etc., do not require metal lathe.

Ensure the same refractory mortar used to build the kit is used to install these materials.

4.0 Installation of Chimney Through a Roof or Structure

A. The chimney is completed by stacking as many flue sections as necessary to reach the desired chimney height. Chimney plumbing can either be straight through the ceiling and through the roof, or if the fireplace is installed on an outside wall, the chimney can be external to the house. When needed, offset blocks can be used for the chimney and should be engineered to structurally support the offset with CMU or custom fabricated steel posts and/or angle iron capable of supporting the weight and height of the chimney. Never exceed more than a 30 degree angle when offsetting a chimney.

B. If chimney exit opening does not already exist locate the point where the chimney will exit the roof by plumbing down to the center of the fireplace chimney. Drive a nail into the roof to mark the center.

C. Measure to all sides of the nail and mark the required opening, and then cut a hole in the roof. Remember that the hole is measured on the horizontal, and then projected to the roof. The hole may then be larger, depending on the pitch of the roof. See Figure 25.

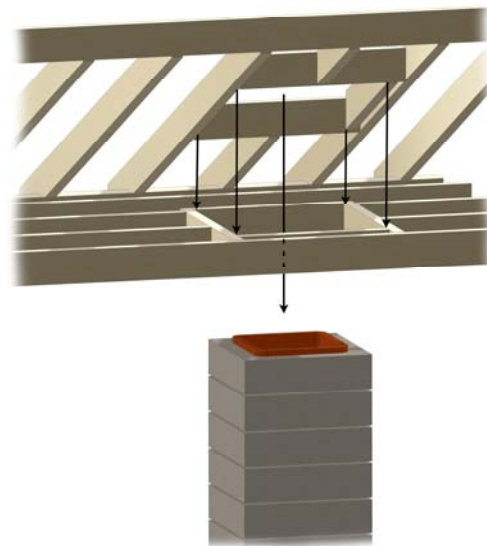

Figure 25. Roof Penetration

D. Frame the opening in the roof, maintaining the required minimum 2" clearances to combustibles around the chimney. See Table 2. When the chimney passes through a ceiling to an upper floor, make sure the 2-inch clearance is maintained with framing where it passes through the ceiling. Exterior veneer attached directly to the chimney measuring 2" or more is acceptable for needed clearance.

WARNING: DO NOT PACK REQUIRED AIR SPACES WITH INSULATION OR OTHER MATERIALS.

E. Continue to add flue sections, extending the chimney through the roof.

F. As the chimney extends through the attic to the

roof, attach securing straps to rafters and joists to provide stability if required by local building code.

G. Install roof flashing appropriate to the roof pitch.

H. At the top of the chimney, use mortar to create a cap, sloping away from the clay flue and running out to the edge of the finish material, to assist with water drainage. Install the chimney cap following instructions provided. This will protect the chimney from rain, birds, animals and leaves. See Figure 26.



Figure 26. Mortar Cap and Chimney Cap

4.1 Height of Chimney

Figure 27 illustrates the proper height of the chimney top. Correct height depends on the chimney's location on the roof and distance from the peak of the roof. Surrounding trees, other buildings and hills may also be a consideration.

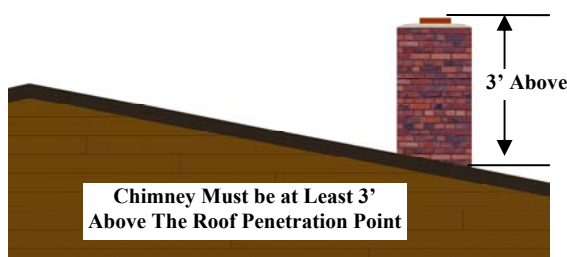
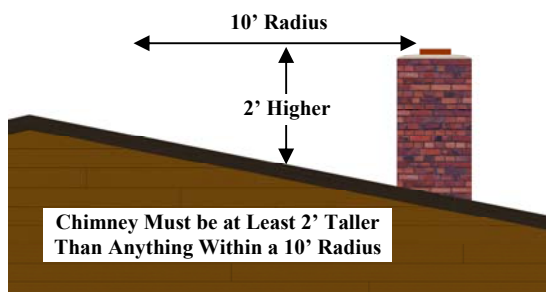

Figure 27. Chimney Height

If the chimney top is not high enough, unusual downdrafts may occur, resulting in undesired smoke spillage. For a more thorough explanation of the figure 27 illustration, this is the traditional 2/10 rule. The center of your chimney should be a minimum of two feet higher than any roof or projection within ten feet horizontally from the chimney center. This means the chimney does not have to extend above the peak of the roof if the peak is more than 10' away horizontally. Once the chimney is ten feet away and extended two feet above roof structure at that distance, the height is sufficient, but it should never be less than three feet taller than the point where it penetrates the surface of the roof.

4.2 Installing a Damper

A. If installing a damper with this model Stone Age fireplace, use a top-mount damper, and follow the instructions included with the damper. Properly orient the taller side of the damper with the prevailing winds in your area. See Figure 28.

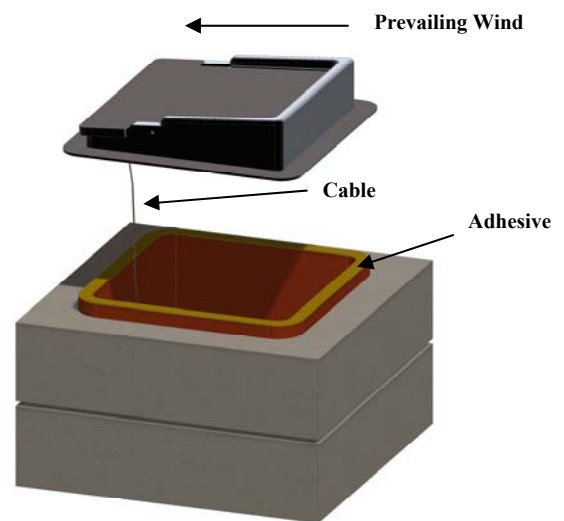

Figure 28. Install Top-Mount Damper

B. Connect the pull cable at the cable guide of the damper and drop through the chimney.

C. Install bracket towards the front of the firebox wall, about 20 inches above the firebox floor. The bracket will capture the damper operating cable. Use a 1/4" masonry bit to avoid cracks in the firebrick. See Figure 29.

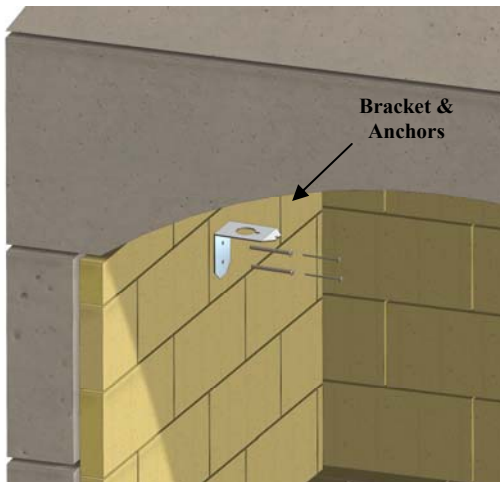

Figure 29. Install Bracket & Anchors

D. Insert the pull cable through the bracket and adjust the length per damper manufacturer's instructions. Attach handle assembly to the bracket and check damper for proper operation. See Figure 30.

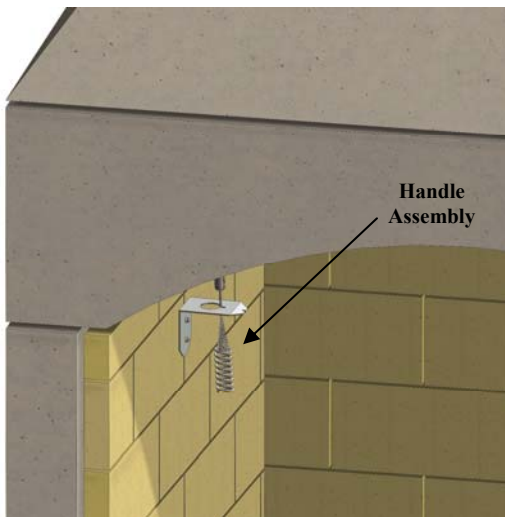

Figure 30. Bracket and Handle Assembly

5.0 Operating Instructions

5.1 Safety Precautions

A fireplace can bring many hours of enjoyment, comfort and warmth if operated and maintained properly. Certain safety precautions must be observed to eliminate the dangers associated with fire and provide a satisfactory, smoke free fire.

A. When burning wood use solid, seasoned wood only. Do not use scrap wood or artificial wax based logs, treated coal or woods dipped in pine tar or pitch.

B. Never use gasoline or other combustible liquids when starting a fire.

C. Keep the chimney damper open while burning a fire. Do not interrupt air flow. Ensure sufficient air is present to support combustion. **The manufacturer of this fireplace is not responsible for interior smoke resulting from lack of combustion air.**

CAUTION: WHEN USING THE DECORATIVE GAS APPLIANCE (VENTED GAS LOGS); THE FIREPLACE DAMPER MUST BE SET IN THE FULLY OPEN POSITION.

D. Keep a screen in front of the fireplace except when tending the fire.

E. Keep combustible furniture/pillows at least four feet from the opening.

F. Never leave the fire unattended.

G. Be extremely careful when adding wood and handling fireplace tools. Never throw, kick or by any other means force wood into the firebox as this could damage the firebrick and fireplace walls that could result in permanent damage and void the warranty. Stress cracks from thermal cycling are normal.

H. Do not alter this fireplace to the extent that it would jeopardize the structural integrity of the fireplace. Drilling or cutting a hole for a gas line, fresh air vent or ash dump is acceptable. Use only Stone Age authorized equipment with this fireplace.

5.2 Selection of Wood

Use cured wood logs only. Scrap wood produces sparks. Treated wood, coal, or woods dipped in pine tar should not be used because they may leave a combustible residue in the fireplace and chimney.

Use of seasoned wood is preferred.

The amount of heat available from logs will depend on the type of wood, its dryness, quantity of wood and the size of the logs. Ten pounds of twigs will produce as much heat as a 10 pound log, but will produce it much faster because the air supply is more available.

5.3 Softwood vs. Hardwood

Wood is divided into two classes, hard and soft woods. Each has a use in a fireplace and each has advantages and disadvantages.

The hardwood category includes such woods as oak, walnut, birch, elm and maple. Softwoods include pine, fir, cedar and spruce.

Selection of wood depends on the type of fire you want. Softwoods are good to offset a morning chill because the fire develops faster. Hardwoods are preferable for a slower burning and uniform heat output.

Softwoods contain a highly flammable resin that will leave creosote soot in the chimney flue. This often results in sparking. Burning softwood exclusively will require more frequent inspection and cleaning of the chimney.

Experienced fire builders often use small amounts of softwood kindling and newspaper when starting a split hardwood log fire.

5.4 Seasoned Wood

Most freshly cut “green” wood will not burn well and will smoke. The pressure of moisture and resin inside green wood will build under heat and explode as sparks. Therefore, it is recommended that only seasoned wood be used in your fireplace.

Most wood requires 9 to 12 months of seasoning and drying to reduce the moisture content enough to produce good steady fires. Ensure that you buy only seasoned wood, or if you buy green wood (usually cheaper), store it properly to aid in the seasoning process. The following steps will assist in the seasoning process.

- A. Stack wood loosely to permit maximum air circulation.
- B. Do not stack wood on the ground. Use a wood rack or stack on scrap lumber. Storage on the ground will cause rotting and insect infiltration.
- C. Cover wood stacks with a tarp so that it is not excessively exposed to the elements such as snow and rain.
- D. Do not stack wood against the walls of your home.

5.5 Building a Fire

A. Use a log grate (sold separately) with your fireplace. This will contribute to good air circulation

around the wood, and keep the wood out of the ash. This grate is shown in Figure 31.



Figure 31. Log Grate

B. Close windows located near the fireplace when first lighting a fire to reduce the possibility of smoking. It can be reopened once a draft has been created through the chimney.

WARNING: NEVER USE GASOLINE, GASOLINE-TYPE LANTERN FUEL, KEROSENE, CHARCOAL LIGHTER FLUID OR SIMILAR LIQUIDS TO START OR “FRESHEN UP” A FIRE IN THE FIREPLACE. KEEP ALL SUCH LIQUIDS WELL AWAY FROM THE FIREPLACE WHILE IT IS IN USE.

- C. Do not overload the wood grate with wood. Three to four logs on the fire at one time are sufficient. Too much wood on the fire at one time can result in “over firing,” and too much heat in the firebox, causing damage to the fireplace.
- D. When lighting a fire in a cold chimney, a downdraft may be created, letting a little smoke into the room. To correct this, hold a wadded newspaper in the firebox and light it. This will create an updraft and clear the flue of cold air.
- E. Remove any excess ash from the fireplace. Excessive ash may reduce airflow. Some owners prefer to leave a small layer to insulate the cold refractory brick below the grate, helping fire starting.
- F. Open and close the damper to ensure it operates properly. Leave it in the full open position when starting a fire and while the fire is burning.
- G. Center the grate over the bottom hearth of the firebox.

H. Crumble several newspapers across the fire area below the grate. Criss-cross kindling wood on top of the grate, above the newspaper.

I. Lay three logs on the grate; two side by side and the third in pyramid fashion on top. Split logs will start faster. Ensure there is space between the logs for air circulation. As the air is heated, it is drawn upwards through the space between the logs, creating more combustion.

J. Light the paper at both sides of the firebox.

Caution: The fireplace requires air for operation. Ensure there is sufficient air so that other fuel burning appliances are not starved of combustion, ventilation, and dilution air.

K. Set the screen in front of the firebox to prevent the escape of sparks and embers.

L. Ensure the fire remains centered in the firebox. Don't let it move to the front part. Move it back with the poker.

M. Add wood to the fire as necessary.

CAUTION: Be extremely careful when adding wood to the fire. Use proper fireplace tools and wear gloves. Un-split logs will be less stable and may be more likely to roll out of the fireplace if not placed carefully on the log grate.

6.0 Cleaning, Inspection and Maintenance

As is the case with most other equipment, cleanliness is the best maintenance practice and will contribute too many hours of warmth and pleasure.

WARNING: DO NOT CLEAN THE FIREPLACE WHEN IT IS HOT.

A. Creosote – Formation and Removal. When wood is burned slowly, it produces tar and other organic vapors, which combine with expelled moisture to form creosote. The creosote vapors condense in the relatively cool chimney flue of a slow burning fire. As a result, creosote residue accumulates on the flue lining. When ignited, this creosote makes an extremely hot fire. The chimney shall be inspected at least twice a year during the heating season to deter-

mine when a creosote buildup has occurred. If a significant layer of creosote has accumulated (3 mm or more), it should be removed to reduce the risk of a chimney fire.

B. Disposal of ashes - Ashes should be placed in a metal container with a tight-fitting lid, and taken outside and placed on the ground, well away from all combustible materials, pending final disposal. If the ashes are disposed of by burial in soil or otherwise locally dispersed, they should be retained in the closed container until all cinders have thoroughly cooled.

C. The grate may be removed from the firebox for cleaning. However, ensure it is returned prior to laying the next fire.

D. Keep the fireplace screen clean so air flows freely through it.

E. Spot check the refractory bricks and mortar for small cracks. It will expand slightly with the heat, and then contract as it cools. Replace refractory bricks when the cracks open more than ¼"; or when pits become extensive and deeper than 3/16"; or when any piece of refractory larger than 2 inches in diameter becomes dislodged.

F. If creosote has accumulated, it should be removed to reduce the risk of a chimney fire. Clean the chimney as outlined below or have the chimney cleaned by a professional chimney sweep.

WARNING: DO NOT USE CHEMICAL CHIMNEY CLEANERS THAT ARE Poured ON A HOT FIRE. THE CHEMICAL CLEANER CAN BE DANGEROUS AND GENERALLY WILL ONLY WORK ON THE FLUE SECTION NEAREST THE FIRE, LEAVING THE REST OF THE FLUE UNAFFECTED.

G. Inspect the top cap and opening in your chimney top and remove any debris that could clog it. If possible, birds will often nest there, and it must be kept clear of nest material.

H. Check the metal flashing and seals around the chimney. Seal any cracks or loose nail heads to prevent roof leaks.

I. Cover the firebox opening with a damp sheet and seal with masking tape to retain soot in the firebox while cleaning.

J. Inspect the entire flue from the top down for obstructions. Use a flexible handled cleaning brush. If the chimney contains offset/return elbows, clean from the top down to the offset, then from the firebox up to the offset.

K. Check the flue from inside the fireplace with the damper open for obstructions.

L. After completion of cleaning, use a vacuum cleaner to remove all soot and residue from the firebox.

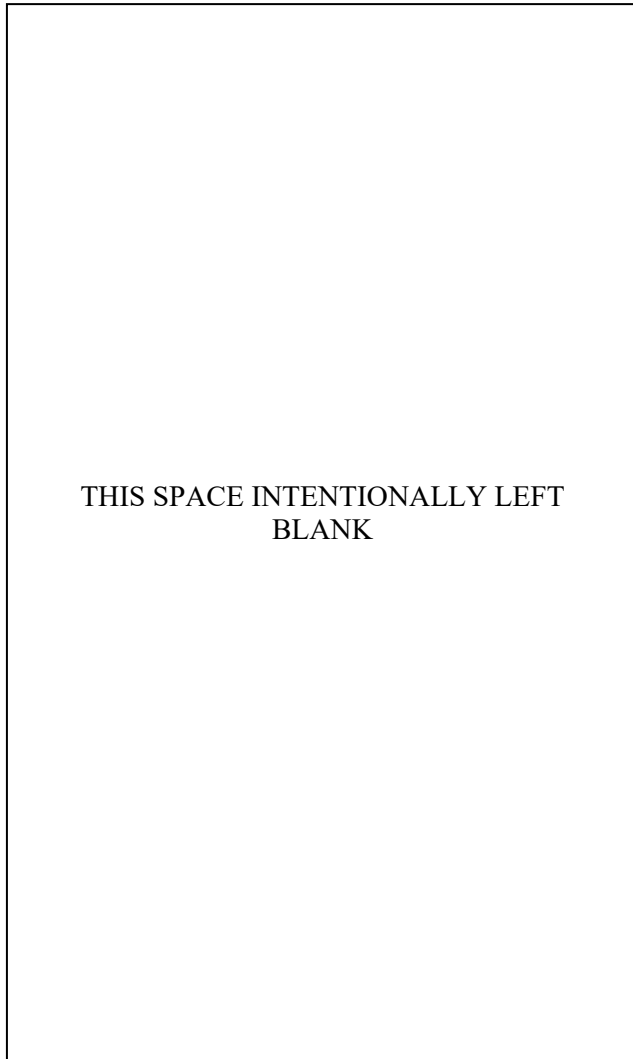

7.0 Finishing Specifications

Approximate finishing specifications, firebrick count, and mortar coverage are estimated in Table 4 below.

Coverage amounts may vary due to weather conditions, type of finish material, size of mortar joints, and skill and efficiency of the mason or installer.

Table 4 does not account for waste. Add the appropriate waste factor for your material type and skill level.

Table 4. Finishing Requirements

Kit Components	
Surface Area	100 square feet
Corner Length	32 Linear feet
Ready-Mix Mortar Required for Kit Assembly	4 Buckets/Bags
Mortar Required for Kit Finishing	4 - 7 Buckets/Bags
Firebrick Required	85 Split Brick
Additional Chimney (Per Chimney Section)	
Surface Area:	4 square feet
Corner Length:	2 Linear feet
Ready-Mix Mortar Required for Assembly	1/8 Bucket/Bag
Mortar Required for Finishing	1/8 - 1/4 Buckets/Bags

Fireplace Components SA36/SA36-STR

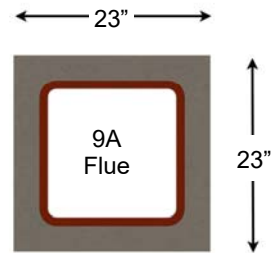
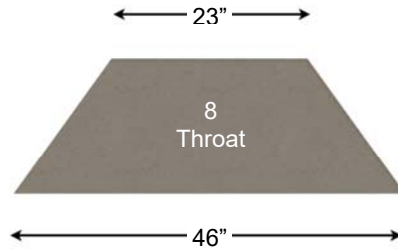
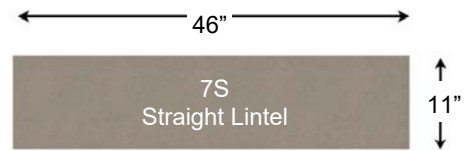
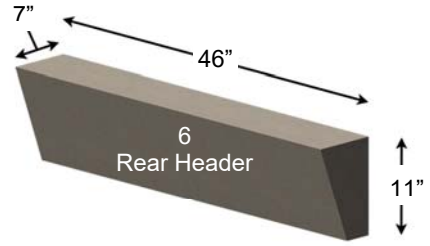
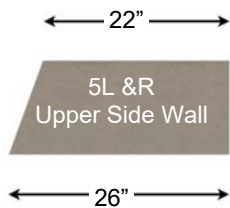
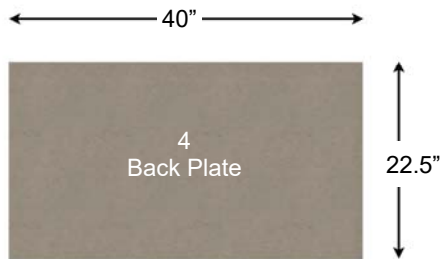
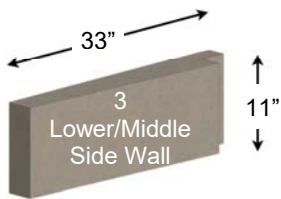
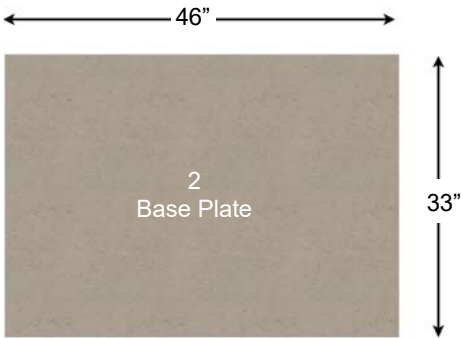
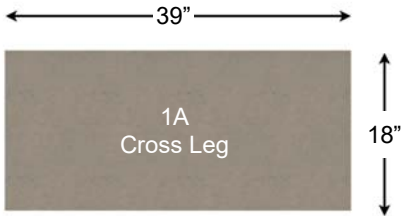
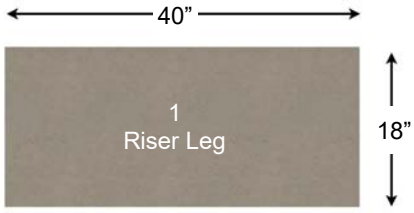

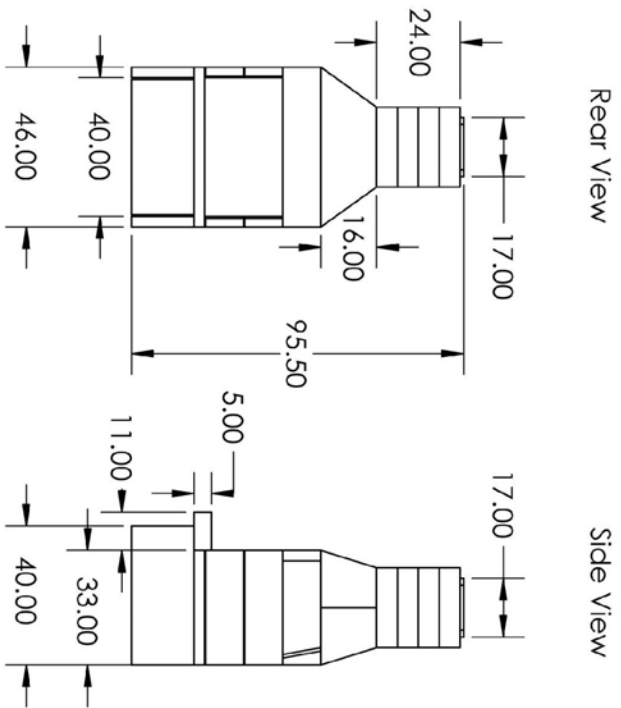

Rear View

Side View

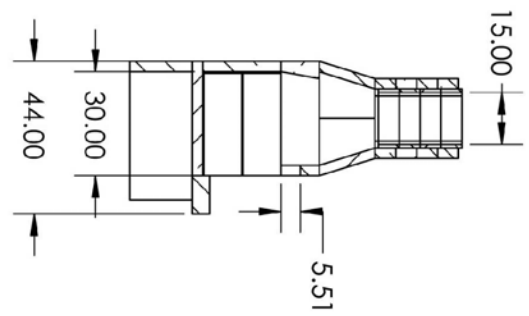

SECTION G-G

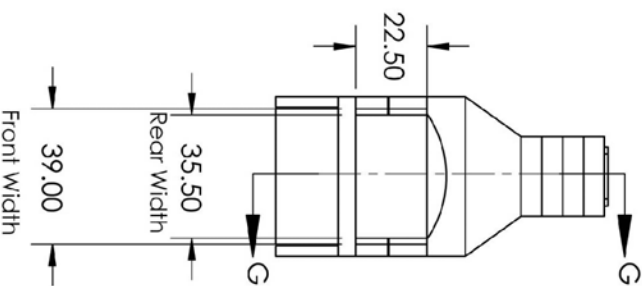

Front View

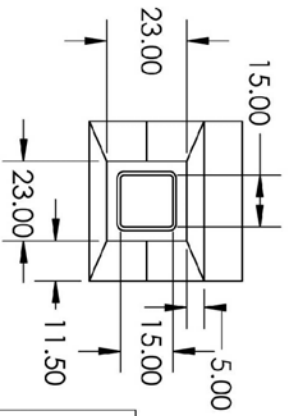

Top View

Firebox widths, without Firebrick

PROPRIETARY AND CONFIDENTIAL
 THE INFORMATION CONTAINED IN THIS DRAWING IS THE SOLE PROPERTY OF STONE AGE MANUFACTURING, INC. ANY REPRODUCTION, IN PART OR AS A WHOLE, WITHOUT THE WRITTEN PERMISSION OF STONE AGE MANUFACTURING, INC. IS PROHIBITED.

UNLESS OTHERWISE SPECIFIED:
 DIMENSIONS ARE IN INCHES
 TWO PLACE DECIMAL ±

MATERIAL

DO NOT SCALE DRAWING

Stone Age
 MANUFACTURING
 Modular Masonry Technology at its Finest
 11107 E 126TH ST. N.
 Collinsville, OK 74021
 918-371-8861

TITLE:
36" Standard Series

SIZE DWG. NO. REV
A SA36-3V

SCALE: 1:48 | WEIGHT: SHEET 1 OF 1

5 4 3 2 1

LIMITED WARRANTY

The products of Stone Age Manufacturing, Inc. (“Stone Age”) have been carefully manufactured and the components assembled to give the customer a quality product. Stone Age warrants to the original purchaser the materials that it provides to the customer against defects in manufacture for a period of twenty-five (25) years from the date of purchase on UL-127 listed fireplaces, for a period of five (5) years from the date of purchase on all unlisted fireplaces, fire pits, and other masonry components. Other accessory items or components offered, but not produced by Stone Age Manufacturing, Inc., shall be covered by their manufacturer’s warranties. This Limited Warranty covers only actual manufacturing defects in the Stone Age product and does not cover defects or faulty workmanship in the installation of the product or the masonry or other structure in which it is installed. Also this warranty does not cover items that have been damaged due to over-heating, modification, improper storage or maintenance. Stone Age shall repair or replace, at its option, any defective Stone Age product component upon receipt of written notice addressed to Stone Age. This Limited Warranty covers only replacement of any defective components within the product itself occurring during the warranty period and does not cover the cost of installation or removal from a fixed location. **NO OTHER WARRANTIES, EXPRESS OR IMPLIED, ARE MADE, INCLUDING IMPLIED WARRANTIES OF MERCHANTABILITY AND FITNESS FOR PARTICULAR PURPOSES WHICH ARE SPECIFICALLY DISCLAIMED.** Stone Age is not liable for damages or injury to persons or property or other incidental or consequential damages.

Stone Age Manufacturing, Inc.
11107 E. 126th St. N., Collinsville, OK 74021
WWW.Stoneagefireplaces.com